

XCell[®] ATF 10 Single-use Device

Start-Up Guide



The information contained in this document is subject to change without notice.

With respect to documentation accompanying product, Repligen makes no warranty, express or implied. Any and all warranties related to the documentation accompanying product are expressly disclaimed. Customer shall refer to the terms and conditions of sale governing the transaction for any and all warranties for the Product.

Repligen Corporation shall not be liable for errors contained herein or for incidental or consequential damages in connection with the furnishing, performance, or use of this material.

No part of this document may be photocopied, reproduced, or translated to another language without the prior written consent of Repligen Corporation.

Products are not intended for diagnostic or therapeutic use or for use in vivo with humans or animals.

For further information, please contact Repligen Corporation at www.repligen.com.

©2023 Repligen Corporation. All rights reserved. The trademarks mentioned herein are the property of Repligen Corporation and/or its affiliate(s) or their respective owners.

Customer Support

customerserviceUS@repligen.com

+1-781-250-0111 (option 1)

Repligen Corporation

41 Seyon Street Building #1, Suite 100

Waltham, MA 02453

www.repligen.com

Contents

1. About this Start-up Guide	6
2. Intended use	6
3. General precautions	6
4. Background	7
5. Product description and accessories	7
5.1 Single-use device	7
5.2 Stainless steel stand	9
5.3 Connection kit (Tubing sets)	9
6. Prerequisites	11
7. XCell ATF 10 Single-use Device connection methods	13
8. Filter wetting approaches	16
8.1 Background	16
8.2 Offline wetting	17
8.2.1 Offline wetting procedure instructions	17
8.2.2 Filter integrity evaluation	19
8.3 Online wetting	21
8.3.1 Online Wetting Procedure	21
9. Post-use instructions	24
10. Frequently asked questions	25
11. Index	26

List of tables

Table 1. Part numbers for XCell ATF 10 Single-use	12
Table 2. Materials of Construction for product contact parts	12
Table 3. Materials of Construction for non-product contact parts	12

List of figures

Figure 1. XCell ATF 10 Single-use Device flow path and stainless steel stand	8
Figure 2. XCell ATF 10 Single-use Device components	9
Figure 3. Connection kit (Tubing sets)	10
Figure 4. Setup of XCell ATF 10 Single-use Device with tube sets	10
Figure 5. Setup of an XCell ATF 10 Single-use Device with a single-use bioreactor	13
Figure 6. Setup of an XCell ATF 10 Single-use Device with a stainless steel bioreactor ...	14
Figure 7. Setup of an XCell ATF 10 Single-use Device with a stainless steel bioreactor ...	15
Figure 8. Required initial setup for the offline wetting of the XCell ATF 10 Single-use Device.....	17
Figure 9. Required, final setup for the offline wetting of the XCell ATF 10 Single-use Device.....	18
Figure 10. Required tubing clamp configuration for disconnecting the feed and permeate wetting bags from the device	19
Figure 11. Required tubing clamp configuration for draining the wetting solution from the device prior to conducting a filter integrity test.....	20
Figure 12. Required configuration for post-wetting device integrity testing	21
Figure 13. Required initial (setup) configuration for the online wetting of the device....	22
Figure 14. Required working configuration for online wetting of the device	23
Figure 15. Configuration for disconnecting the collection bag from the device	24

Abbreviations

A2B	XCell ATF Device to Bioreactor Connection
A2C	XCell ATF Device to Controller Connection
ABS	Acrylonitrile Butadiene Styrene
ATF	Alternating Tangential Flow
DAC	Disposable Aseptic Connector
FIT	Filter Integrity Test
LMH	Liter per meter sq. per hour
LPM	Liter per Minute
PES	Polyethersulfone
PMMA	Poly (methyl methacrylate)
PS	Polysulfone
PVDF	Polyvinylidene Fluoride
SCCM	Standard Cubic Centimeter per Minute
SS	Stainless-Steel
SU	Single-use
SUB	Single-use Bioreactor
WFI	Water for Injection

1. About this Start-up Guide

This Start-Up Guide is for individuals who are planning to use the Repligen XCell® ATF 10 Single-use Device as a cell retention device for perfusion cell culture. Although this device is very similar to the XCell ATF 10 Stainless Steel Device, this guide provides advice on making the appropriate connections, preparing the device for use, and initiating the cell culture process, all while maintaining sterility throughout the fluid path.

After reading this document, you will be familiar with all system components, and you will be able to complete the appropriate connections and configure the system to support the intended process. This guide is not intended to provide guidance on the optimization of the XCell ATF 10 Single-use Device operation or to provide guidance on controlling the cell culture process.

2. Intended use

The XCell ATF 10 Single-use Device is intended to be used as a cell retention device to support a high cell density and high viability cell culture operation. The device is designed to enable linear scaling from XCell ATF 2 to XCell ATF 10 Device to support multiple scales of cell culture development and cGMP manufacturing. Although it is possible that the use of this device represents an initial step into this type of processing, it is assumed that similar processing with the smaller scale XCell ATF 2 or XCell ATF 4 Systems or the XCell ATF 6 Stainless Steel System has been performed. Therefore, there is a presumption that the individuals following this guide are already skilled in the areas of aseptic technique, process scale fluid handling, interfacing the XCell ATF Device with the bioreactor and the use of the Repligen XCell C410 Controller. Additional information on the use of XCell ATF Systems can be found in the XCell ATF System with C24 Controller and XCell ATF System with C410 Controller User Guides.

3. General precautions

The sterile connections between the XCell ATF 10 Single-use Device, tubing sets, and the bioreactor are made by utilizing GE ReadyMate™ Disposable Aseptic Connectors (DACs) or CPC AseptiQuik® X Connectors. For installation and operation, multiple, varying flow path configurations need to be established by moving tubing clamps along the flow path.

It is important to use sterile technique when making sterile connections. Once the ReadyMate connections have been made, the supplied nylon tri-clamp should be installed to secure the aseptic connector assembly (this is not applicable for AseptiQuik X Connectors). Once the sterile connectors are secured, there should be no concern for either liquid leakage or a possible introduction of contamination during the process. It is important to ensure the tubing pinch clamps are correctly positioned to establish the required and correct flow path. Operating single use systems with the pinch clamps requires attention to detail and frequent reassessment of the desired flow paths to ensure that none of the terminating end points are allowed exposure to the atmosphere. Since the pinch clamps can create significant force when crimped, causing the tubing to remain closed when the clamp is released, it is best to inspect the tubing carefully to ensure it is open, and if necessary, to massage or roll the tubing carefully to open it and reestablish flow.

The XCell ATF10 Single-use Device is supplied pre-sterilized and only requires wetting with sterile cell culture media or WFI prior to use. There is no need to sanitize a device prior to use. The devices are designed to be single-use and are therefore not designed to be cleaned, sanitized, and stored for repeat use. The device should not be exposed to high pH solutions, such as sodium hydroxide for extended time. Repligen advises not to expose the device to even dilute caustic solutions prior to use or for storage. If caustic is used for post use decontamination, the concentration should be limited to 0.1 N and the contact duration limited to one hour.

Note: Refer to the XCell C410 Controller User Guide for controller related precautions.

4. Background

The XCell ATF 10 Single-use Device is a highly efficient cell retention device that features gentle, low shear diaphragm pumping action to avoid shear stress on the cells. This system is utilized in numerous cell culture applications including continuous bioprocessing (perfusion), N-1 perfusion for seed train optimization, high density cell banking and high yield harvest or clarification of fed-batch cultures.

The XCell ATF 10 System is also available in the original stainless-steel formats. Using the gamma-irradiated/pre-sterilized XCell ATF Single-use Device eliminates the need for autoclave procedures, enables faster implementation time, reduced downtime between cell culture runs and reduced validation time and expense.

The XCell ATF 10 Single-use Device is supplied dry. It is recommended to pre-wet the device before use to ensure optimal filter performance. This document describes the installation procedure for the XCell ATF 10 Single-use Device and tubing sets.

5. Product description and accessories

The XCell ATF 10 Single-use Device is supplied as a gamma irradiated/pre-sterilized device. The device should be placed in the stainless-steel support stand, provided as an accessory, prior to use to ensure operational stability. A tubing set with six unique components is also offered to ensure proper and sterile connectivity.

5.1 Single-use device

The XCell ATF 10 Single-use Device components are a diaphragm pump, filter housing, inlet elbow and a hollow fiber filter cartridge fitted within the filter housing. The unit contains five ports/connection points: top retentate port, condition/drain port, top permeate port, bottom permeate port and A2C (XCell ATF to Controller) port. Except A2C ports, all other ports are supplied dead-ended with GE ReadyMate DACs or AseptiQuik X Connectors (Figure 1).

Figure 1. XCell ATF 10 Single-use Device flow path and stainless steel stand

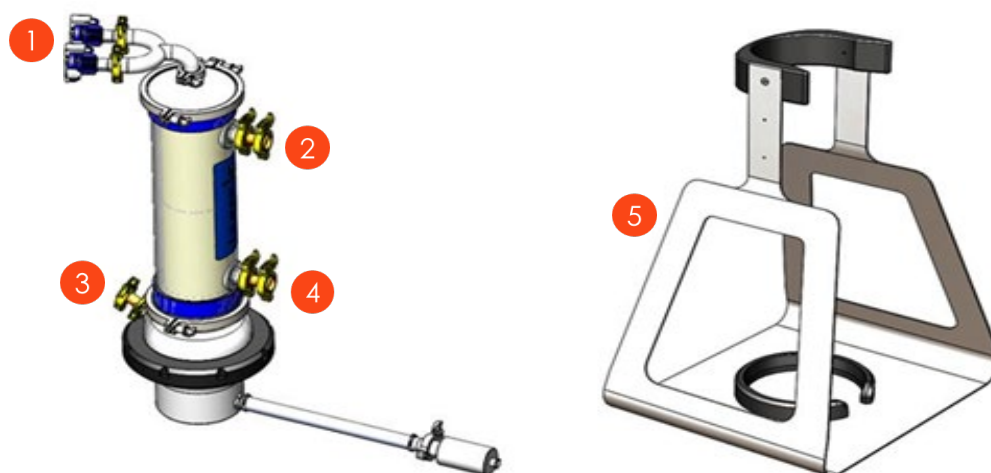

1. Top retentate (AseptiQuik X Connectors)
2. Top permeate (GE ReadyMate)
3. Condition/drain port (GE ReadyMate)
4. Bottom permeate (GE ReadyMate)
5. Stainless steel stand

The A2C port is connected to the P-box of the XCell C410 Controller allowing pressurized air and vacuum to be delivered actuating the diaphragm. The other four ports are liquid carrying lines that enable filter cartridge preparation and operation. Two ports are connected to the feed side of the cartridge and the other two ports are connected to the permeate cavity. The top retentate port is used to make a connection between the XCell ATF 10 Single-use Device and a bioreactor using two A2B tubing sets. Typically, the top permeate port is used for harvesting purposes and the lower permeate port remains closed off throughout the process but could be aseptically connected to a pressure transducer to monitor the permeate pressure during the process.

The hollow fiber cartridge is an integral element within a clear housing. The spherical chamber at the base encompasses the silicone diaphragm which moves up and down as a function of the pressurized air and vacuum flow on the bottom half of the sphere. The clear housing enables the viewing of the diaphragm movement. [Figure 2](#) illustrates the components of the XCell ATF 10 Single-use Device.

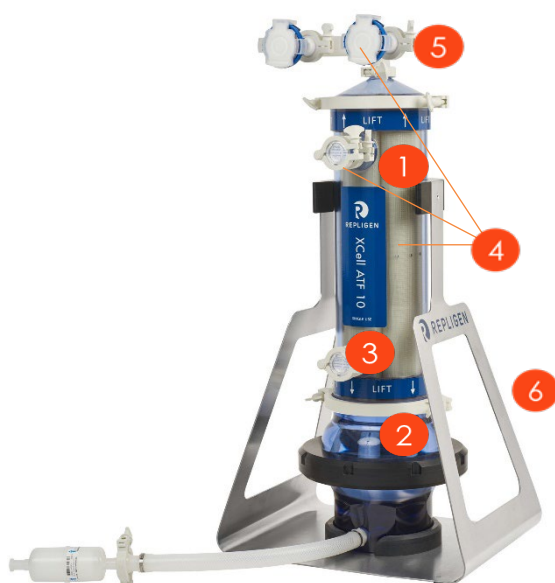
Figure 2. XCell ATF 10 Single-use Device components

1. Hollow fiber filter:
PES or PS, Epoxy, and Polypropylene
2. Diaphragm pump:
Silicone
3. Port adhesive:
Acrylated Urethane
4. Housing, Pump hemisphere and
Aseptic connectors:
Polycarbonate
5. Inlet elbow and U-Connector:
PVDF
6. Stand:
Stainless steel

5.2 Stainless steel stand

To ensure stability during setup and use, it is recommended that the device be placed in the stainless steel, reusable stand. The stand features a ring to hold the bottom of the device securely and a snap ring to hold the filter housing near the top of the device. The device snaps into the stand with a single click. After use, the device can be easily removed from the stand. The stand is provided with a notch to orient and secure the A2C line. This feature also helps orient the entire device for efficient connectivity and easy access to all the ports.

Note: The stainless steel stand needs to be ordered separately from the XCell ATF 10 Single-use Device.

5.3 Connection kit (Tubing sets)

The connection kit contains six individual tubing elements, designed to ensure proper XCell ATF 10 Single-use Device functioning. Each tubing element is supplied with the required pinch clamps and sanitary clamps, which are utilized to isolate different fluid paths during the device setup and to secure the sterile connectors respectively. All tubing components are constructed of silicone and are configured with vent filters and GE ReadyMate/AseptiQuik X Sterile Connectors. The tube set contains two A2B lines, one with vent filter and one without, and are configured with AseptiQuik X Connectors to make a connection between the XCell ATF 10 Single-use Device and a bioreactor. All tubing sets are sterilized by gamma irradiation and packed in double plastic bags. A description and the intended purpose of each tubing element and setup are noted in [Figure 3](#) and [Figure 4](#).

Figure 3. Connection kit (Tubing sets)

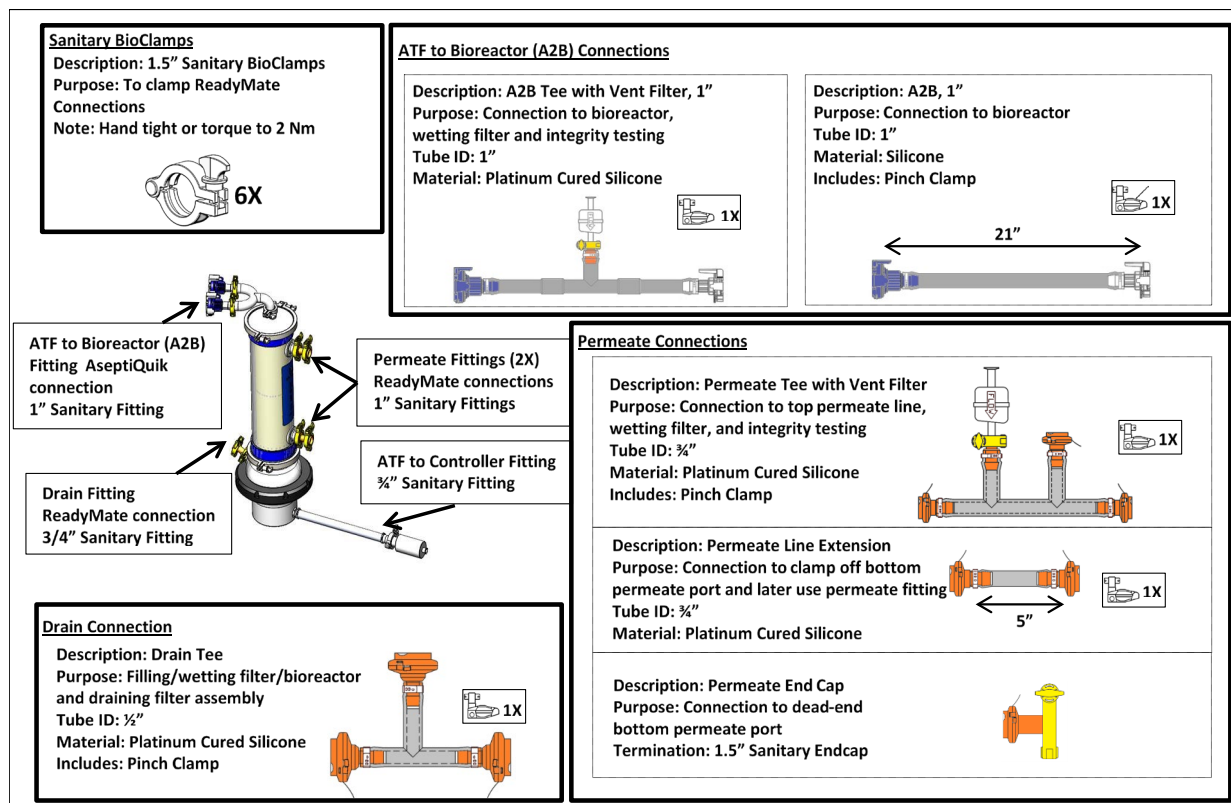
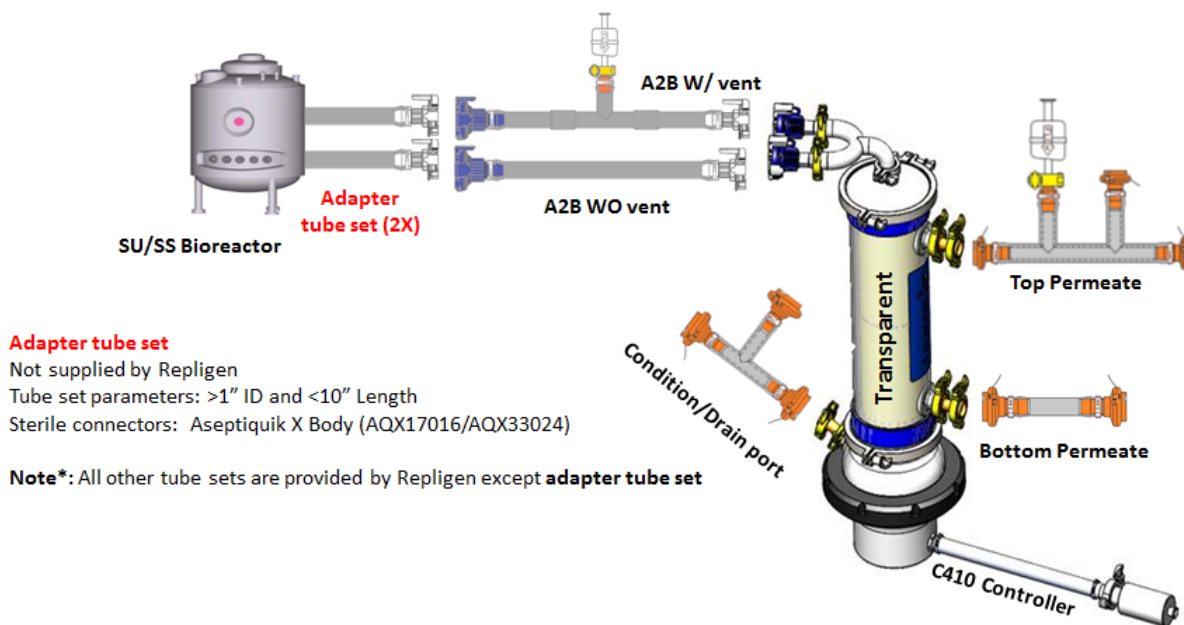

Figure 4. Setup of XCell ATF 10 Single-use Device with tube sets



The pinch clamps are used during pre-use wetting process and perfusion operations to isolate various fluid paths after use.

Note: Unlinked GE ReadyMate and AseptiQuik X Connectors are not water resistant, so in order to maintain systems sterility, extra care must be taken during setup to not to introduce liquid onto the connector.

Note: The connection kit (tubing set) needs to be ordered separately from the XCell ATF 10 Single-use Device.

6. Prerequisites

The following non-supplied equipment is required to operate the XCell ATF 10 Single-use Device:

1. For XCell ATF 10 Single-use Device Operation.
 - a. An operational, calibrated XCell C410 Controller, connected to the required air pressure and vacuum pressure sources.
2. For Permeate (Harvest) Flow
 - a. A variable speed peristaltic pump able to support flow rates in the range of 0.4 - 2.5 L/min depending on the bioreactor working volume and perfusion rate.
 - b. A minimum length of 1/4" to 3/8" inch ID tubing, fitted with a single ReadyMate Aseptic Connector to mate with the XCell ATF 10 Single-use Device. It is recommended that the permeate line be sterilized via gamma irradiation or autoclaving.
3. For Pre-use, Offline Wetting

Note: This is explained in [Section 8.2.1](#), and may not be required.

- a. Two hundred and twenty liters (220L) of 0.2 µm filtered WFI or cell culture media dispensed into a Single-use bio container (bag) that is fitted with an appropriate length of tubing, a clamp, and a single, terminal ReadyMate Aseptic Connector.
- b. A sterile 220 L empty single-use bio container (bag) with an appropriate length of tubing, a clamp, and a single, terminal ReadyMate Aseptic Connector.
- c. Variable speed peristaltic pumps with flow capacity of 2 - 15 LPM, and able to accommodate the tubing IDs configured on the 220 L WFI media bag.

Table 1. Part numbers for XCell ATF 10 Single-use

Part	Description	Notes
suATF10-G02PS	XCell ATF 10 Single-use Device, 0.2 µm PS	0.2 um filter, ReadyMate and CPC Sanitary Connections
suATF10-S02PES	XCell ATF 10 Single-use Device, 0.2 µm PES	0.2 um filter, ReadyMate and CPC Sanitary Connections
suATF10-STAND	XCell ATF 10 Single-use Stand	Stainless steel reusable stand
suATF10-TubeSetKit	XCell ATF 10 Single-use Tubing Set	(6) Individual Tube Sets. Doesn't include adapter tube sets.
RM-10319	Left facing bi-valve Left facing bi-valve	Only for use with stainless steel bioreactors
RM-10318	Right facing bi-valve	Only for use with stainless steel bioreactors

Table 2. Materials of Construction for product contact parts

Device component	Materials of Construction
Filter housing and pump	Polycarbonate
Adhesive	Acrylated Urethane
Tubing	Platinum Cured Silicone and C-Flex (both part of tubing set)
Elbow	Polyvinylidene Fluoride (PVDF)
ReadyMate DAC	Polycarbonate with silicone seal
AseptiQuik Connectors	Polycarbonate with silicone seal
Hollow Fiber Cartridge	PES Membrane - Polyethersulfone, Epoxy, and Polypropylene PS Membrane - Polysulfone, Epoxy, and Polypropylene
Gaskets and Diaphragm	Silicone

Table 3. Materials of Construction for non-product contact parts

Device component	Materials of Construction
Tubing and sanitary clamps	Glass-Filled Nylon
Pump closure ring	ABS
Stand	ABS, SS

7. XCell ATF 10 Single-use Device connection methods

The following schematics illustrate the connection methods of XCell ATF 10 Single-use Device to stainless steel and single-use bioreactors.

Figure 5. Setup of an XCell ATF 10 Single-use Device with a single-use bioreactor

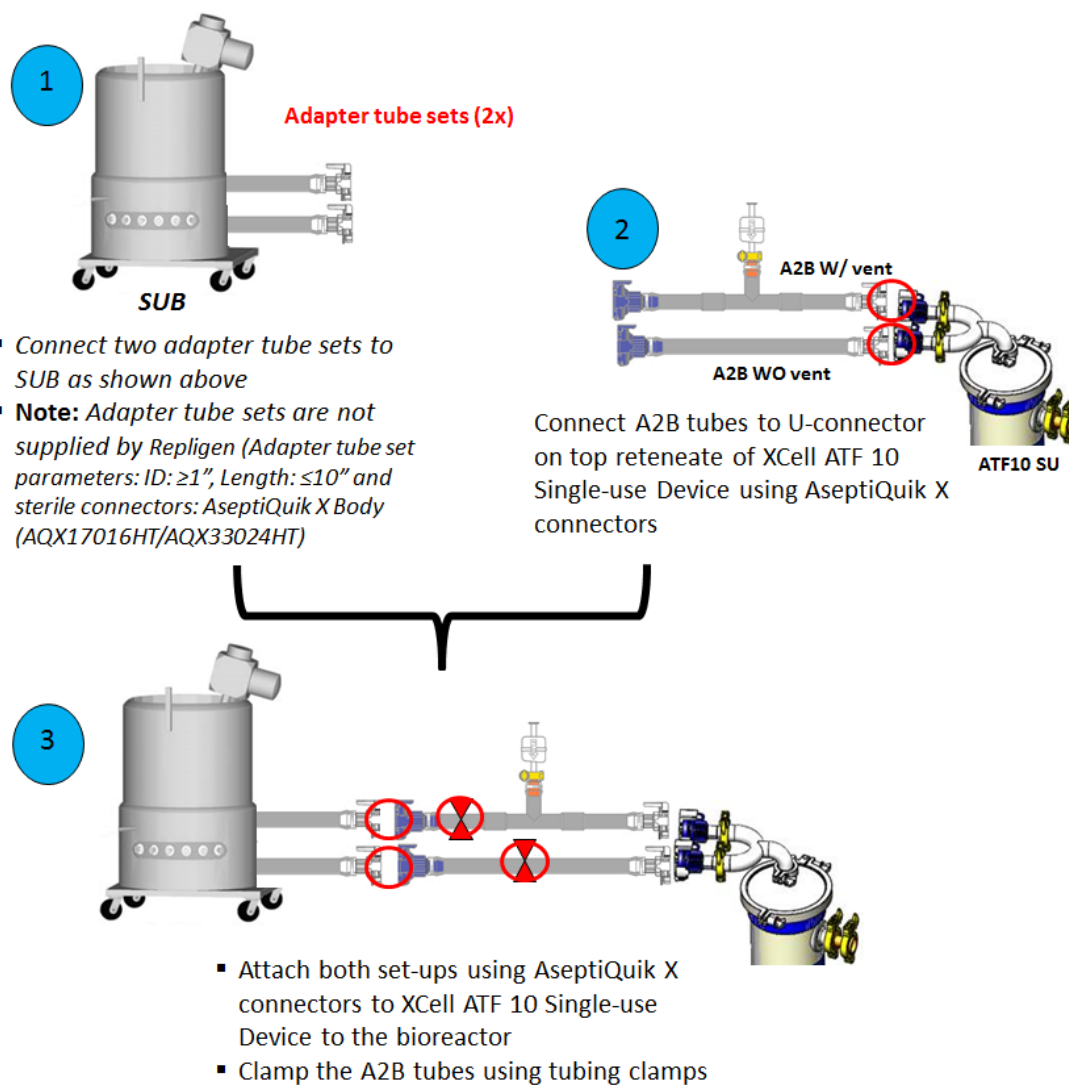

Note: Please refer to [Table 1](#) for required part numbers.

Figure 6. Setup of an XCell ATF 10 Single-use Device with a stainless steel bioreactor

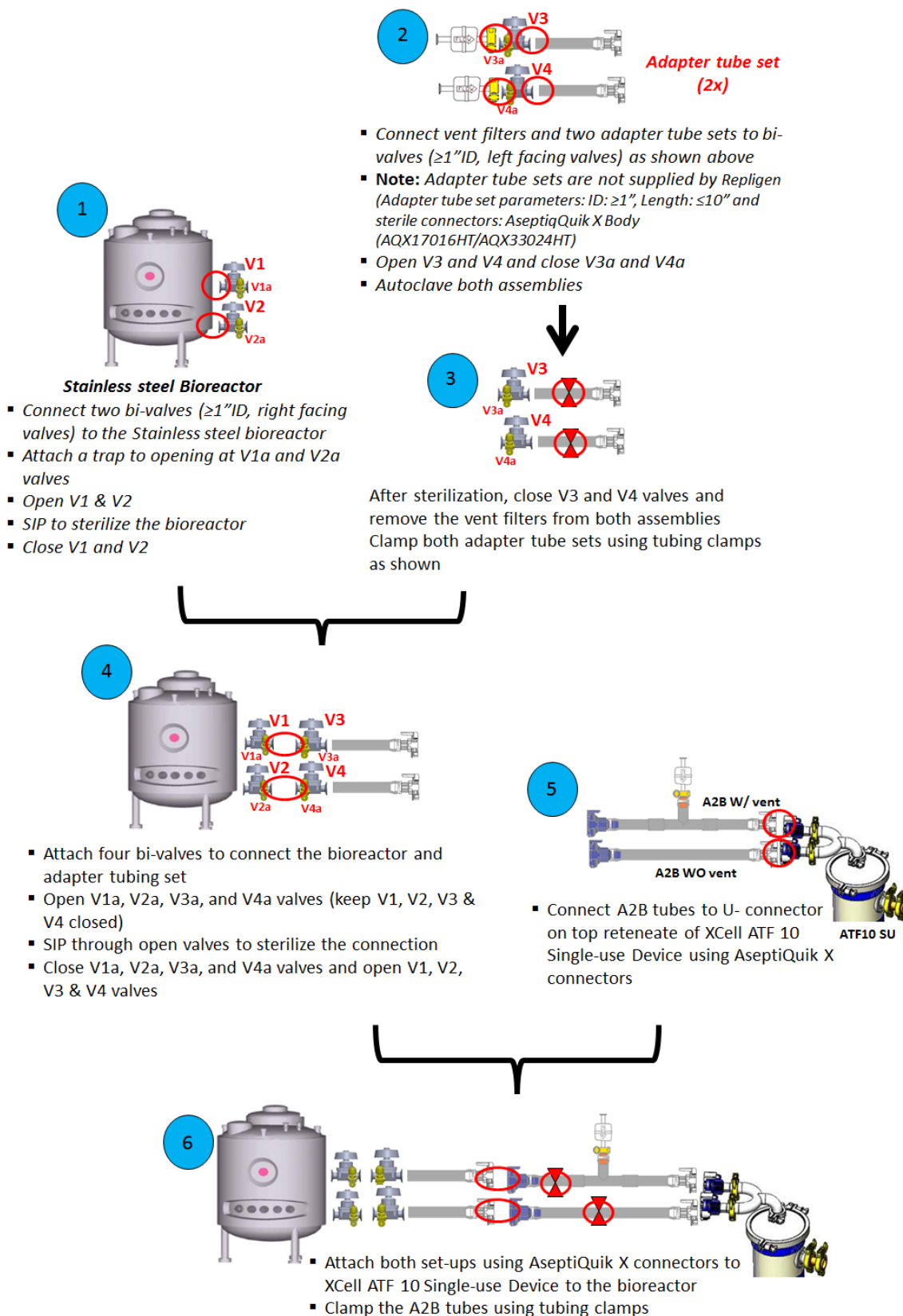

Note: Please refer to [Table 1](#) for required part numbers.

Figure 7. Setup of an XCell ATF 10 Single-use Device with a stainless steel bioreactor

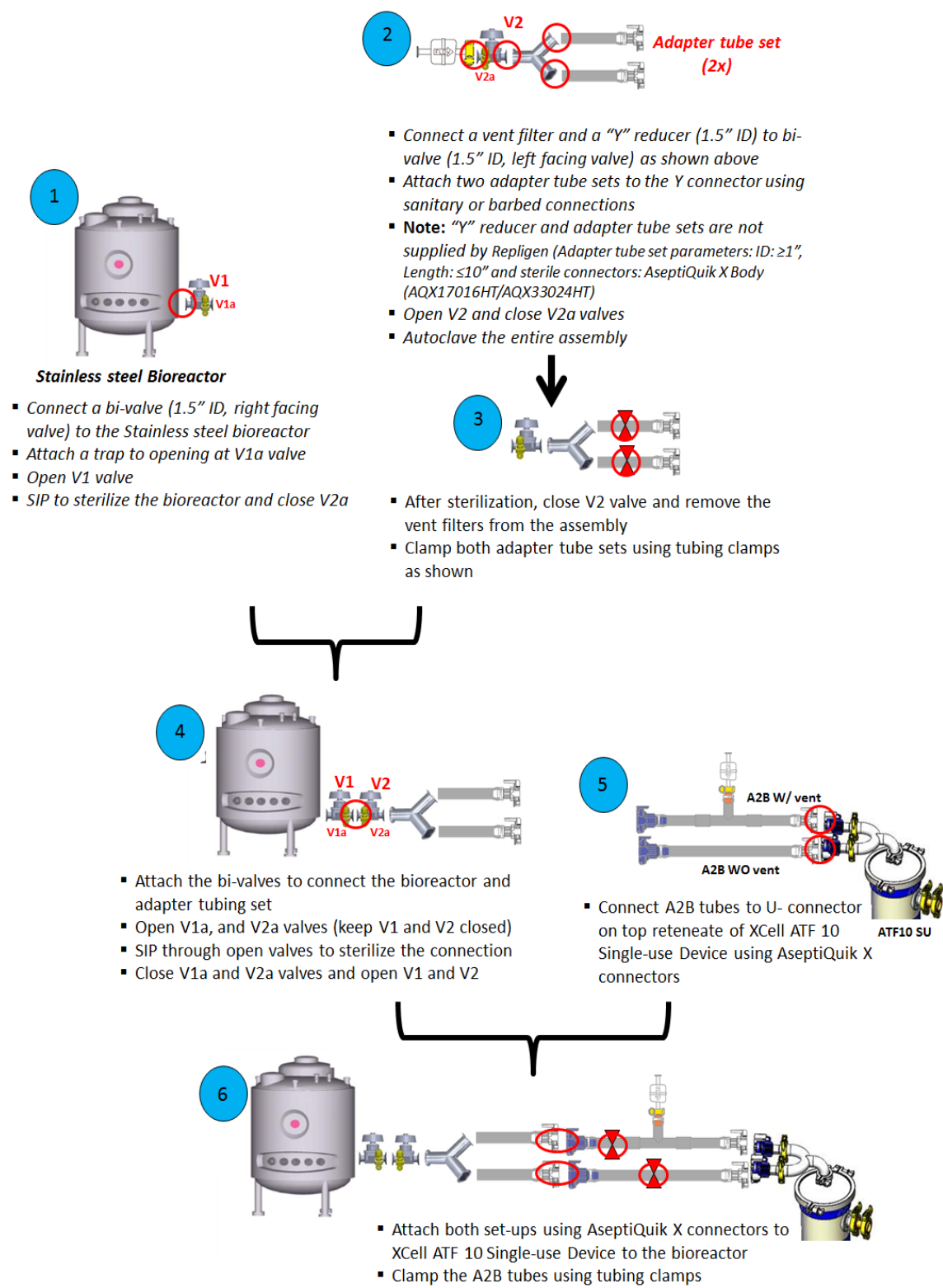

Note: Please refer to [Table 1](#) for required part numbers.

8. Filter wetting approaches

8.1 Background

The XCell ATF 10 Single-use Device is supplied dry and has not been pre-wetted or conditioned. Wetting of the hollow fiber filter in the device is required to ensure robust filter performance. A minimum of 220L of sterile water or cell culture media (recommended) is required to properly wet the filter. The sterile wetting solution should be filled into a single-use container (bag) fitted with a ReadyMate Connector. A second, empty bag (hold-up volume >220 L), also fitted with a ReadyMate Connector is required for collection of wetting solution that will be collected from the filter permeate side during the filter wetting procedure. These two components are not supplied with the XCell ATF 10 Single-use Device. A stand-alone peristaltic pump, capable of accommodating the bag tubing and delivering flow rates of ≥ 8 LPM is also required and not supplied.

Two methods, **offline wetting** or **online wetting**, can be used to wet the hollow fiber filters. Each method is detailed below.

Offline wetting allows for the filter in the device to be wetted while not connected to a bioreactor and without the use of the XCell C410 Controller and the resulting pump action. The offline wetting configuration and process also allows for pre-use filter integrity testing (optional, but recommended) to be accomplished while maintaining sterility.

The on-line wetting procedure is executed with the device connected to a bioreactor that contains sterile cell culture media (pre-inoculation). This method utilizes the XCell C410 Controller to generate the pump action to wet the filter.

The offline wetting procedure is recommended for the following reasons:

- Filling the unit from the condition/drain port wets the membrane inside-out, which drives more uniform wetting of the filter and minimizes the formation of air bubbles inside the filter.
- This method allows the user to test filter integrity while disconnected from the bioreactor and maintaining sterility. Integrity testing a filter prior to use reduces process risk.
- Upon completion of the wetting process with cell culture media, the media can be incubated overnight to evaluate the sterility of the device before making a connection to the bioreactor.
- If there is need to replace the device during a run, using the offline technique does not require the use of the XCell C410 Controller or for the device to be connected to a bioreactor, which may be in use. Therefore, offline wetting must be used in replacing a single-use device during an active perfusion cell culture run.

Note: *Online wetting also allows testing filter integrity and sterility check. However, the benefit is diminished as the device is sterilely connected to a bioreactor prior to these testing.*

8.2 Offline wetting

8.2.1 Offline wetting procedure instructions

For an overview of the XCell ATF Single-use Device [offline wetting process](#), please refer to the linked video.

1. Install the device into the stand and attach the tubing sets to set up the XCell ATF 10 Single-use Device for the offline wetting procedure (the stand is not shown in [Figure 8](#) for better visualization of the tubing sets).
 - a. Set up the device as shown in [Figure 8](#).

Figure 8. Required initial setup for the offline wetting of the XCell ATF 10 Single-use Device

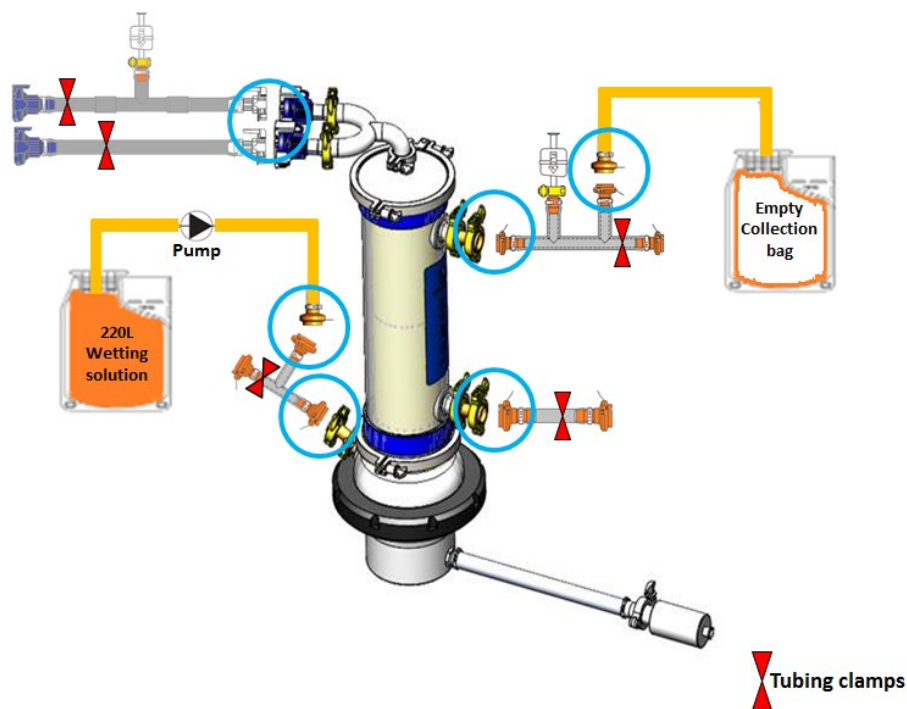

- b. For an overview of making the required sterile connections, please refer to the GE [ReadyMate](#) and [AsepticQuik](#) X Connectors installation videos.
 - c. Remember to secure a tri-clamp on a coupled GE ReadyMate Connector to ensure the connection will be integral to the required operating pressures (this is not applicable for AsepticQuik Connectors).
 - d. It is important that the pinch clamps are placed in the proper locations ([Figure 8](#)) to ensure effective filter wetting and to prevent the accidental wetting of the vent filters and/un-linked sterile connectors.
 - e. Prepare a single-use container (bag) containing 220 L wetting solution (WFI or sterile media) and fitted with a GE ReadyMate Connector.
 - f. Similarly, prepare another empty single-use container (bag) fitted with a GE ReadyMate Connector.
2. Using the GE ReadyMate Connectors, connect a 220 L bag containing the sterile wetting solution to the drain port and an empty 220 L bag to the top permeate port respectively.
 3. Ensure all tubing clamps are positioned and secured as noted in [Figure 8](#). Begin pumping the sterile wetting solution through the Condition/Drain port at a flow rate of 2 LPM to fill the device with wetting solution. When the solution begins to fill the top permeate port, stop

the pump immediately, clamp the top permeate port completely such that both vent filter and empty bag segments are closed. Restart the pump briefly to fill the top retentate, when solution begins to fill the U-connector, stop the pump and clamp the vent filter segment to close the top retentate completely.

Note: Ensure that the wetting solution does not contact the vent filters or the unlinked sterile connectors at any point during the wetting process. Add a clamp to the top permeate tubing set to isolate (close) the vent filter line, leaving the line to the collection bag open ([Figure 9](#)).

Figure 9. Required, final setup for the offline wetting of the XCell ATF 10 Single-use Device

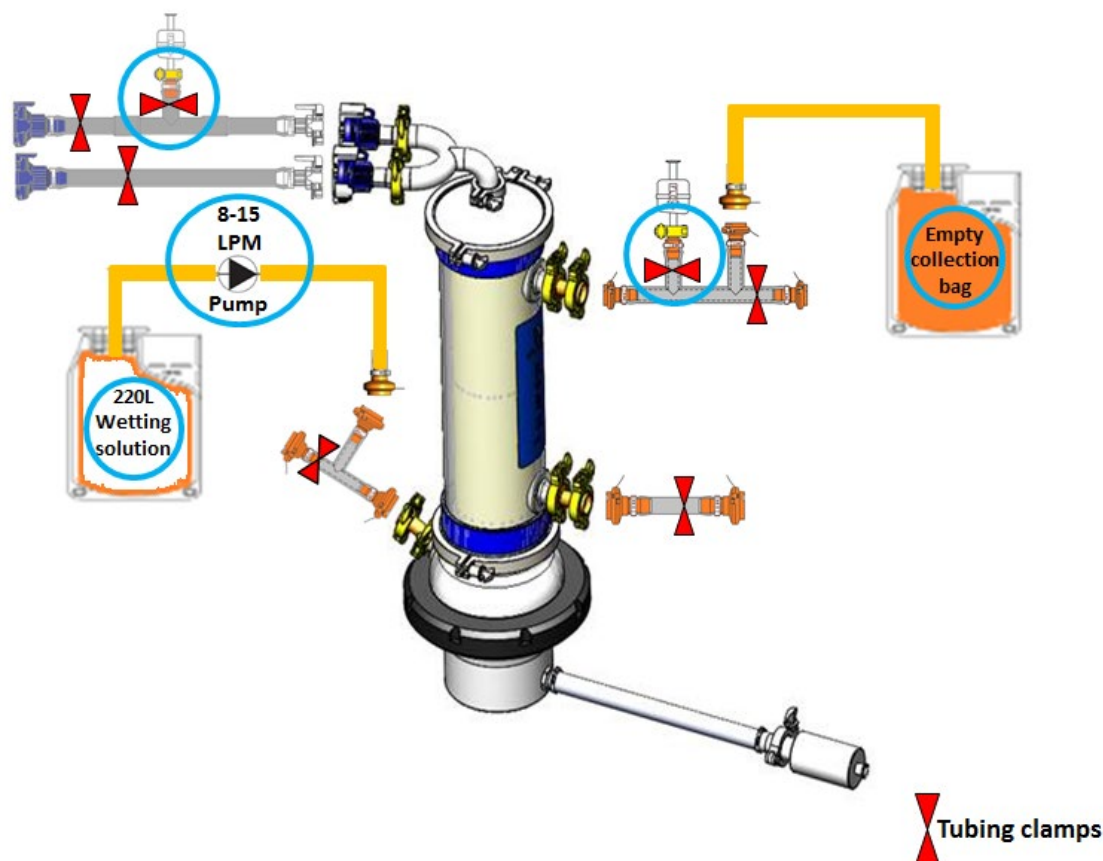

1. Now, restart the pump at any flow rate between 8 - 15 LPM and continue until the entire 220 L of sterile wetting solution has passed through the device and into the permeate collection bag to ensure complete wetting of the filter ([Figure 9](#)).
2. If a filter integrity test is required, proceed to [Section 8.2.2](#). Otherwise, continue to Step 4 to complete the offline wetting process.
3. After wetting, disconnect the wetting solution feed and collection bags from the device in a sterile manner by clamping the respective tubing sets ([Figure 10](#)).
 - a. If cell culture media was used for wetting, the media collected in the permeate bag can be used to assess the sterility of the device by incubating it in a shake flask.

Figure 10. Required tubing clamp configuration for disconnecting the feed and permeate wetting bags from the device

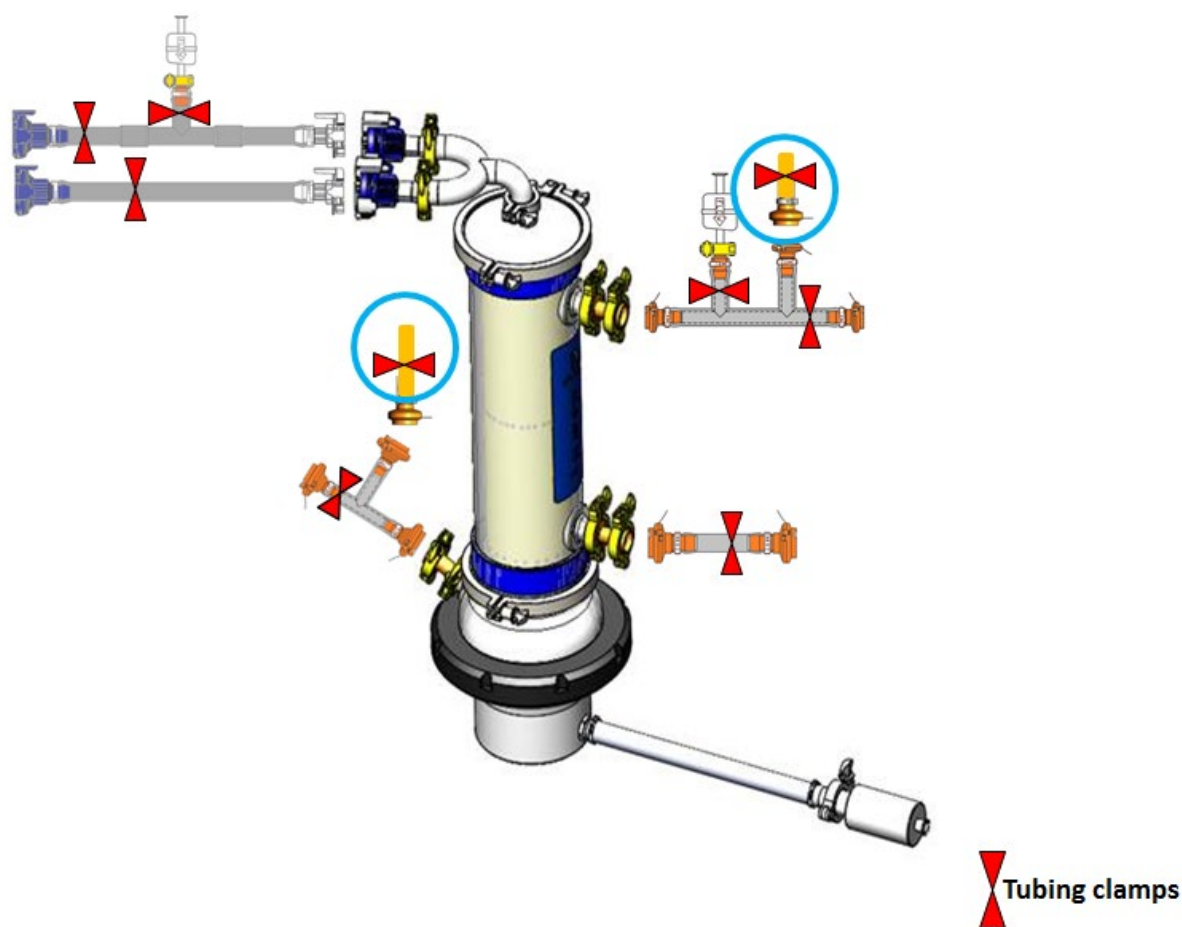

4. The wetting solution can remain inside the device until the unit is ready to be connected to the bioreactor. Ensure that tubing lines to the vent filters on the top retentate and top permeate tubing sections are clamped.

8.2.2 Filter integrity evaluation

1. To test the filter integrity, the wetting step must be complete and the wetting solution must be drained from the device.
2. Remove the clamps at the vent filters on both the top retentate and top permeate ports.
3. Close the line to the collection bag with a clamp ([Figure 11](#)). Ensure that the Condition/Drain port clamp is positioned as noted in [Figure 11](#).

Figure 11. Required tubing clamp configuration for draining the wetting solution from the device prior to conducting a filter integrity test

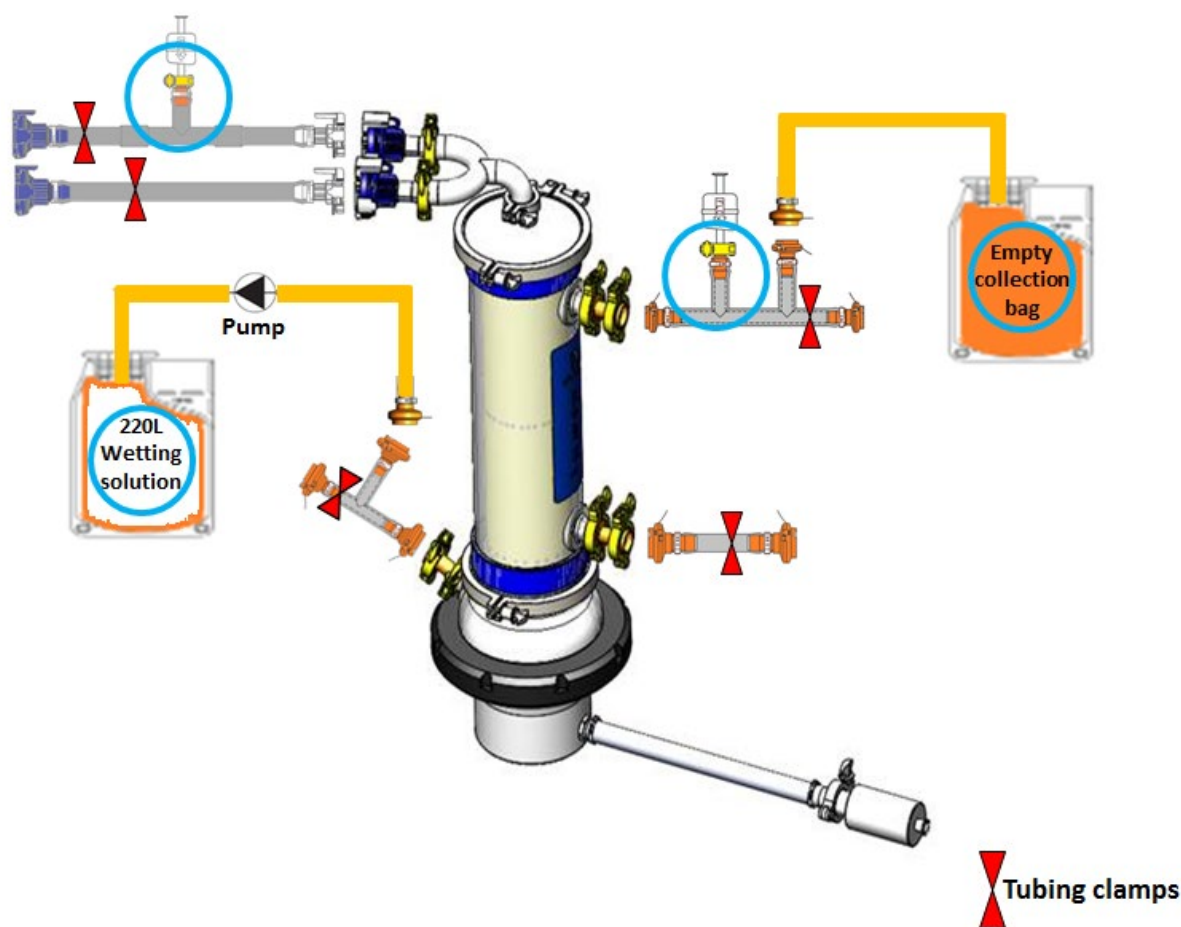

1. Start the pump in reverse flow at flow rate of no more than 1 LPM in order to drain the wetting solution to the bag from Condition/Drain port.

Note: The draining process will not remove all of the solution from the diaphragm pump. The presence of residual wetting solution in the pump will not affect the filter integrity evaluation or the functionality of the device.

2. After draining the wetting solution, stop the pump and disconnect the bags from the device in a sterile manner by clamping the respective tubing lines.
3. The device integrity can now be evaluated using a forward air diffusion test by connecting an FIT tester or a pressure source with an inline 0 - 30 psi pressure gauge to the vent filter on the top retentate tubing set.
 - a. Ensure that the vent filter on the top permeate tubing is open for diffused air to escape and all remaining pinch clamps are tightened to avoid leaks.
4. Pressurize the unit through the top retentate port vent filter to 10 psi and monitor the pressure decay for 5 min (Figure 11). The average pressure decay should not exceed 0.5 psi/min (diffusion rate should be <math><30 \text{ SCCM/m}^2</math>) for the unit to pass the filter integrity testing.

Note: To avoid filter drying, it is recommended to clamp the segments leading to vent filters on both permeate and retentate side after FIT evaluation. Other pinch clamps can remain at same locations ([Figure 12](#)).

Figure 12. Required configuration for post-wetting device integrity testing

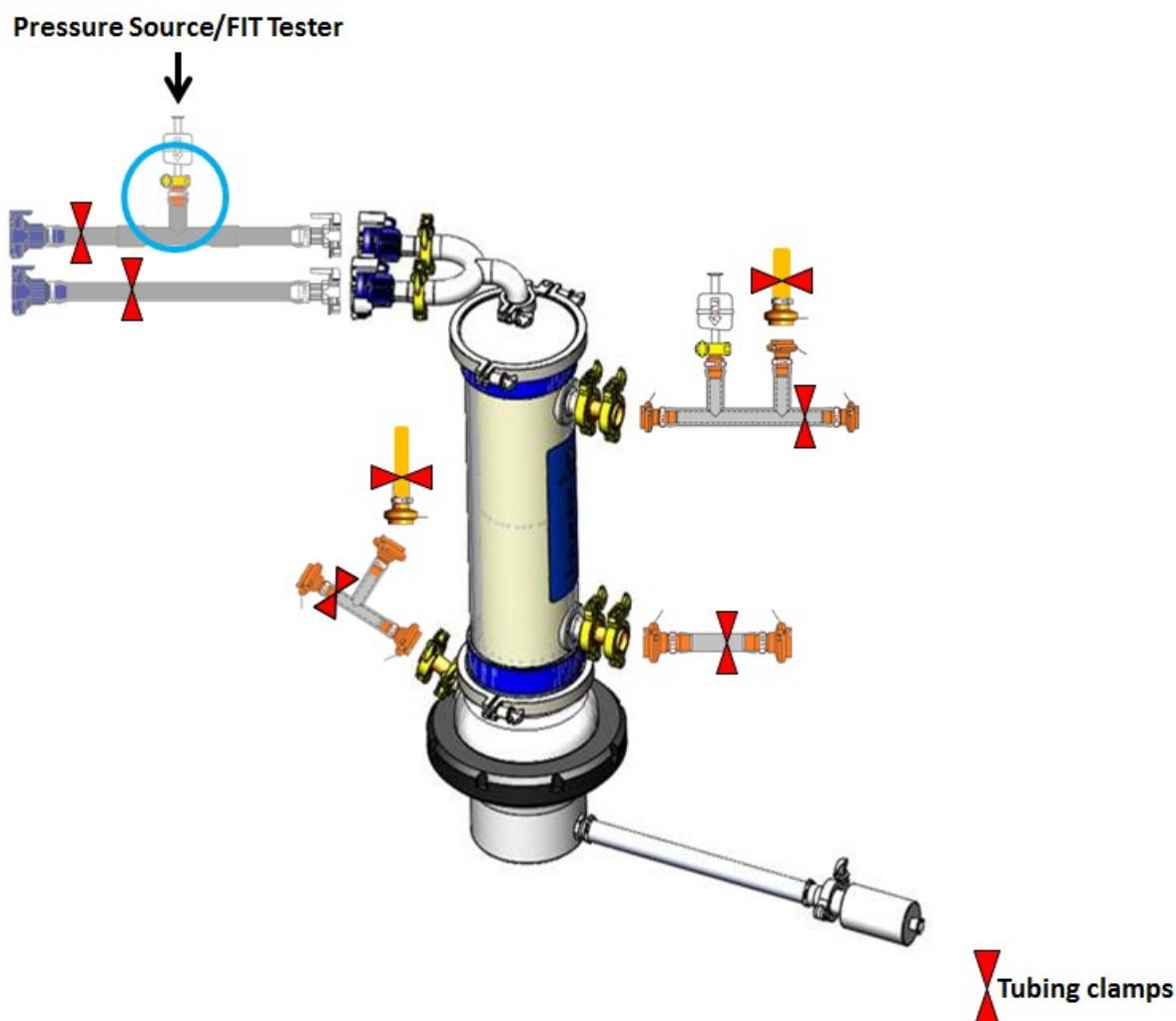

8.3 Online wetting

The XCell ATF 10 Single-use Device filter can also be wetted using an on-line procedure, where the device is wetted after the connection is made to a bioreactor. The XCell C410 Controller is used to wet the filter membrane. This method is not amenable to performing a pre-use integrity test.

8.3.1 Online Wetting Procedure

1. Prepare the bioreactor as is required for the cell culture process. The bioreactor must contain sterile cell culture media and be cell free (pre-inoculation) for use in wetting. The device wetting should be executed prior to the bioreactor being inoculated.
2. Set up the XCell ATF 10 Single-use Device by setting the device into the stand (the stand is not shown in [Figure 13](#) for better visualization of the tubing pieces).
3. Prior to connecting the device to the bioreactor, ensure that all tubing sets and pinch clamps are installed ([Figure 13](#)).

Figure 13. Required initial (setup) configuration for the online wetting of the device

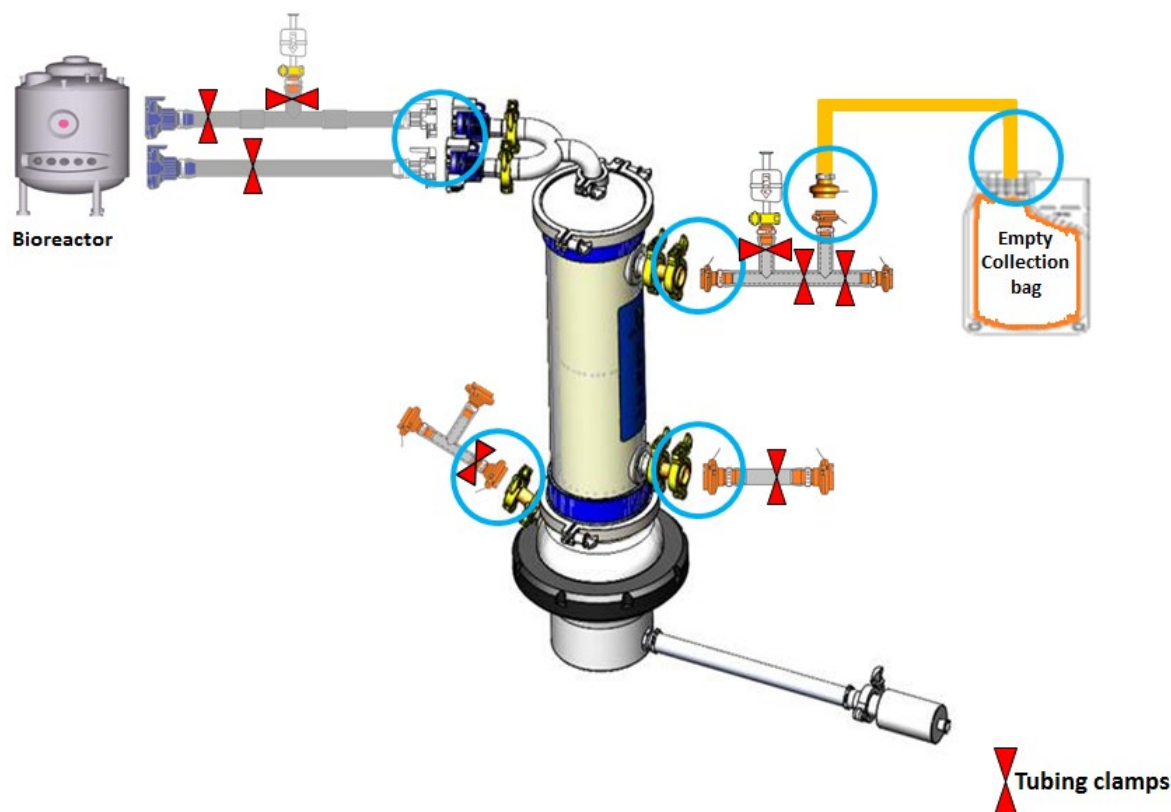

1. For an overview of making the required sterile connections, please refer to the GE [ReadyMate](#) and [AseptiQuik](#) X Connectors installation videos.
 - a. Remember to install a tri-clamp on a linked GE ReadyMate Connector to ensure proper connection and integrity to the required operating pressures (this is not applicable for AseptiQuik Connectors).
 - b. It is important that the pinch clamps are placed in proper locations ([Figure 12](#)) to prevent accidental wetting of vent filters and un-linked GE ReadyMate Connectors.
2. After installation of the pinch clamps, connect the device to the bioreactor using both A2B tubing sets ([Figure 12](#), refer to [Section 7](#) for connection methods).
3. Connect the XCell C410 Controller to the device via the A2C connection. Refer to the XCell C410 User Guide for additional instruction on the operation of the XCell ATF.
4. Prepare an empty single-use bag (hold-up volume >220 L) fitted with a GE ReadyMate Connector.
5. Using the GE ReadyMate Connect the empty 220 L bag to the tubing segment attached to the top permeate port ([Figure 13](#)).
6. Remove both clamps on the top retentate tubing segment such that the line between the bioreactor and the device is open.
 - a. Ensure that tubing to the vent filter on the top retentate is clamped.

Note: Bioreactor head pressure may force the media into the device without the ATF action.

7. Start the XCell ATF Pump from the XCell C410 Controller at a flow rate of 60 LPM (P & E) and let it run for 5 minutes till all air bubbles disappear.

8. After equilibration, remove the clamp to the empty 220 L bag on the top permeate port and immediately start the top permeate pump at any flow rate between 8 - 15 LPM.
9. Collect at least 220 L of wetting solution in the top permeate collection bag (Figure 14).

Figure 14. Required working configuration for online wetting of the device

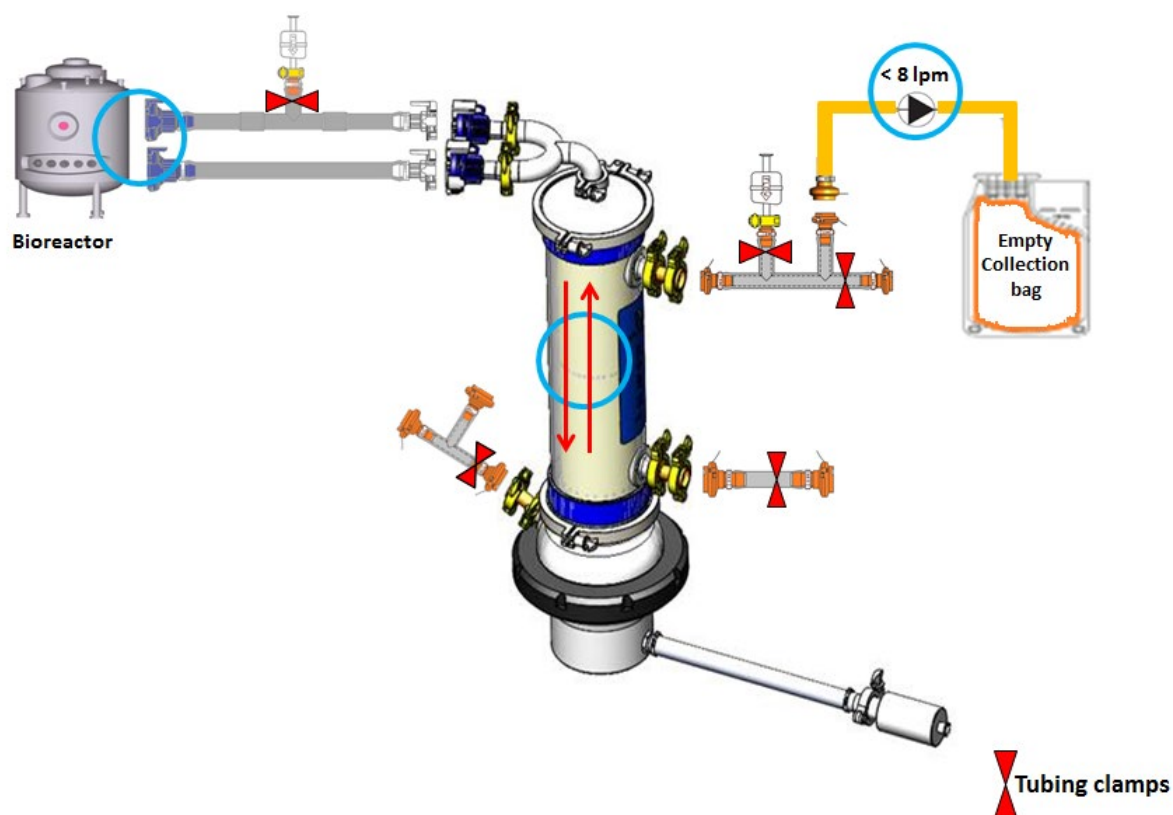

10. After completion of the on-line wetting process, stop the permeate pump and then the XCell ATF Pump. Clamp both A2B tubing lines and disconnect the collection bag from the top permeate port in a sterile manner by clamping the tube (Figure 15).
 - a. The media from the collection bag can be used to determine the sterility of the wetted XCell ATF 10 Single-use Device.

Figure 15. Configuration for disconnecting the collection bag from the device

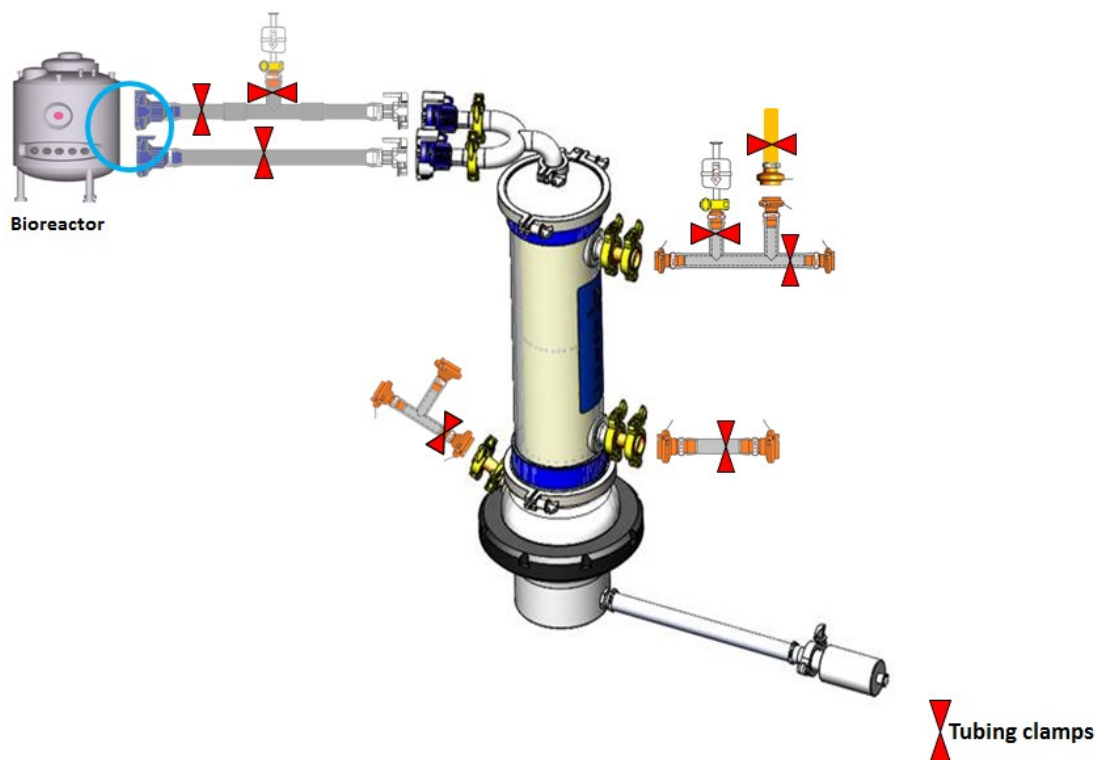

11. The remaining solution inside the device can be left as-is, until the bioreactor is ready for the perfusion process.
 - a. Both the retentate and permeate vent filters need to be closed before starting the perfusion process.

9. Post-use instructions

After completion of a cell culture process using the XCell ATF 10 Single-use Device, use the following instructions to empty and discard the device.

1. Stop the permeate pump and disconnect the harvest bag in a sterile manner.
2. Stop the XCell C410 Controller to stop the pump action and disconnect the XCell ATF 10 Single-use Device from the controller using A2C line.
3. Clamp A2B lines and top permeate tubing line using tubing clamps.
4. Prepare an empty bag or a container (>25 L) fitted with a ReadyMate Connector. Using the ReadyMate Connector, connect the empty bag/container to the drain port.
5. Remove the clamps at the vent filters on both the top retentate and top permeate ports. Detach the clamp at drain port to drain the culture into the empty bag.
6. Begin the draining of cell culture solution through the condition/drain port at a flow rate of 2 LPM to the bag/container.

Note: The device may need to be tilted to drain the cell culture solution from the diaphragm pump.

7. After draining, stop the pump and disconnect the bag from the device. Discard the device.

10. Frequently asked questions

What do I do if a vent filter gets wet during the wetting process?

Vent filters are made of hydrophobic membrane; wetting solution getting in contact with vent filters for short duration (<15 minutes) does not impact the integrity and sterility of vent filter and XCell ATF 10 Single-use Device. We recommend purging the vent filter to remove the residual solution.

What do I do if a leak is detected during the offline wetting procedure?

Each individual device is pressure tested at 25 psi to ensure the integrity of the entire assembly. However, if a leak is detected during wetting process, immediately stop the peristaltic pump and identify the location of the leak. Please ensure that the sterile connectors and tubing clamps are appropriately installed at proper locations. Clamping wrong tubing sets during wetting procedure pressurizes the device and leads to leakage. If no faults were found in setup, please contact a local Sales Manager or customer service for further support.

How do I ensure the sterility of an XCell ATF 10 Single-use Device?

The wetting solution collected from offline wetting procedure can be incubated in a shake flask at 37°C for 24 hours to assess the sterility of a device.

How long can the XCell ATF 10 Single-use Device be stored in a wet condition before connecting to a bioreactor?

After completing the wetting procedure, the tubing segment leading to the vent filters on the A2B and the top permeate tubing segments must be clamped to avoid filter drying. The device can be stored in a wet condition for one week before installing the device for cell culture processing.

What do I do if the device fails pre-use integrity testing?

Please ensure that the tubing clamps on the retentate side are properly installed. Generally, if the filter integrity is failed by small percentage (acceptance criteria: 30 SCCM/m²), it is recommended to wet the filter again using the same procedure. If a gross leak is detected during integrity, please contact a local Sales Manager or customer service for further support.

Does the XCell ATF 10 Single-use Device perform similarly to XCell ATF 10 Stainless Steel Device?

Yes, the filter used in the XCell ATF 10 Single-use Device is same as the one which is being used in the XCell ATF 10 Stainless Steel Systems. In addition, the single-use device is operated using the same XCell C410 Controller as stainless steel without modifying any parameters and the pumps between the stainless steel and Single-use equipment is identical.

11. Index

AseptiQuik.....	6, 7, 9, 11, 12, 17, 22	Hollow fiber filter.....	7, 16
Cell retention	6, 7	Online wetting	21, 22, 23
Connection kit.....	9, 10	Tubing set.....	12
GE ReadyMate	6, 7, 9, 11, 17, 22	Wetting procedure	17, 21